

System Summary

The **SFES PRO** TOS-16 Single System provides excellent sediment filtration, chlorine removal and mineral scale control for water-fed equipment such as ice machines, coffee/tea machines, bakery equipment, etc.

The system utilizes a premium high grade carbon block filter ensuring high flow rates and treatment volumes.

The TOS-16 Single System also incorporates the patented HydroBlend™/ScaleStick™ scale control insert providing unparalleled mineral scale prevention and corrosion control for predictable treatment periods.

The **SFES PRO** Single Head is available in 3 different connections: 3/8" MNPT (310303), 3/8" FNPT (310306) & 3/8" QD Push Connect (310309)



Benefits

Mineral scale buildup responsible for increased maintenance is reduced

Removes sediment that causes cloudy ice and plugs distribution tubes and float valves

Energy efficiency and machine life are increased while reducing costly service calls

Removes chlorine to improve taste and reduce potential corrosion issues

Features

Bayonet style quick disconnect cartridge makes filter replacement sanitary, quick and easy

Compact design facilitates system placement and installation

HydroBlend™/ScaleStick™ insert provides optimum scale prevention and a consistent feed throughout the life of the cartridge

NSF Certified under Standard 42

Installation Summary

Place system in an accessible location for ease of filter replacement

Ensure that the system is mounted vertically with a minimum of 2" clearance from the bottom of the system to allow for filter replacement

Cold water inlet feed only

Do not over tighten fittings

Operating Tips

Recommended cartridge replacement every 6 months

Application

Ice Machines

Coffee/Tea Equipment

Proofers, Deck/Rack Ovens

System Specifications

Rated Service Flow

2.0 gpm. (7.57 lpm.)

Rated Capacity

15,000 gal. (Chlorine Removal)

Operating Pressure

30 - 125 psi. (2 - 8.6 bar) non-shock

Operating Temperature

35° - 100°F (2° - 38°C)

Connection Size

3/8" MNPT, FNPT, QD Push Connect

Shipping Weight

3 lbs.

System Dimensions

20.85" x 4" x 4" (HxWxD)

*Width w/ 3/8" Male Fittings: 6"

*Width w/ 3/8" Cross Kit: 8"

Warranty

PRO systems are covered by a limited warranty against defects in material or workmanship for a period of 1 year after the date of purchase.

PRO replacement filters are covered by a limited warranty against defects in material or workmanship for a period of 1 year after the date of purchase.

Please call 1-800-935-8500 for further warranty information.

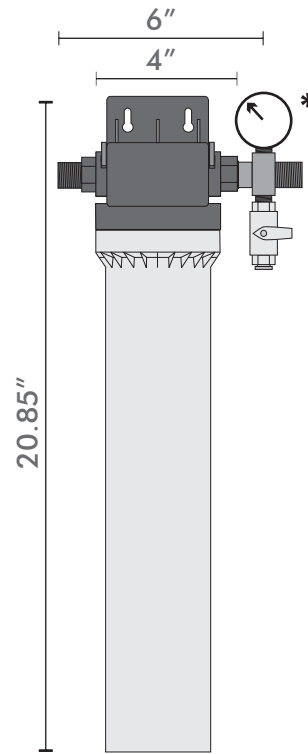

Replacement Filter(s)

(1) 310366 - PRO TOS-16 Cartridge

* Additional Accessory

(1) 310338 - 3/8" Cross Kit w/ Valve & Gauge

Additional Info

Do not use with water that is microbiologically unsafe or unknown quality without adequate disinfection before or after the system

System should be installed in compliance with state and local laws and regulations.



System Tested and Certified by NSF International against ANSI/NSF Standard 42 for the reduction of Chlorine, Taste and Odor.