

System Summary

The **SFES PRO** TOF-16 Single System provides excellent sediment filtration and chlorine removal for beverage related equipment such as soda systems, juice machines and drinking water

The system utilizes a premium high grade carbon block filter that specializes in higher sediment loading capacity ensuring great tasting drinking water and beverages.

The **SFES PRO** Single Head is available in 3 different connections: 3/8" MNPT (310303), 3/8" FNPT (310306) & 3/8" QD Push Connect (310309)



Benefits

Consistent high quality and great tasting beverages

Reduced costs since costly over compensation of syrup is not needed to mask chlorine taste

Higher beverage carbonation increasing effervescence helping eliminate flat drinks

Features

Bayonet style quick disconnect cartridge makes filter replacement sanitary, quick and easy

Compact design facilitates system placement and installation

NSF Certified under Standard 42

Installation Summary

Place system in an accessible location for ease of filter replacement

Ensure that the system is mounted vertically with a minimum of 2" clearance from the bottom of the system to allow for filter replacement

Cold water inlet feed only

Do not over tighten fittings

Operating Tips

Recommended cartridge replacement every 6 months

Application

Drinking Water

Soda Systems

Juice Machines

System Specifications

Rated Service Flow

2.0 gpm. (7.57 lpm.)

Rated Capacity

12,000 gal. (Chlorine Removal)

Operating Pressure

30 - 125 psi. (2 - 8.6 bar) non-shock

Operating Temperature

35° - 100°F (2° - 38°C)

Connection Size

3/8" MNPT, FNPT, QD Push Connect

Shipping Weight

3 lbs.

System Dimensions

20.85" x 4" x 4" (HxWxD)

*Width w/ 3/8" Male Fittings: 6"

*Width w/ 3/8" Cross Kit: 8"

Warranty

PRO systems are covered by a limited warranty against defects in material or workmanship for a period of 1 year after the date of purchase.

PRO replacement filters are covered by a limited warranty against defects in material or workmanship for a period of 1 year after the date of purchase.

Please call 1-800-935-8500 for further warranty information.

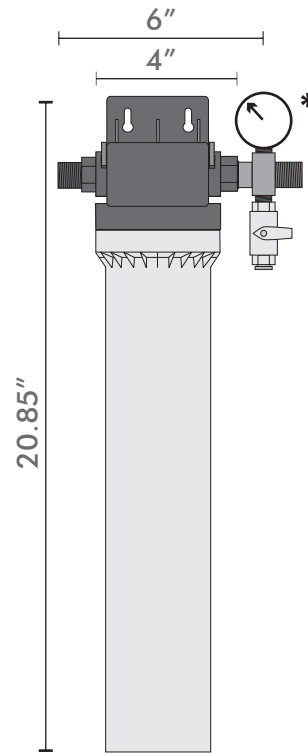

Replacement Filter(s)

(1) 310374 - PRO TOF-16 Cartridge

* Additional Accessory

(1) 310338 - 3/8" Cross Kit w/ Valve & Gauge

Additional Info

Do not use with water that is microbiologically unsafe or unknown quality without adequate disinfection before or after the system

System should be installed in compliance with state and local laws and regulations.



System Tested and Certified by NSF International against ANSI/NSF Standard 42 for the reduction of Chlorine, Taste and Odor.